

CI CONTEMPORARY
2 Handle Lavatory Faucet (w/ Pop-Up Waste)
(3 Holes)



Features

- Contemporary styling
- TOTO aerated water technology, ECOCAP adds air to the water to achieve full water jet with less amount of water usage

Specifications

Finish: Chrome
Material: Brass
Water Pressure: 0.05MPa~0.75MPa

Parts description

- **DL226-2**
2 Handle Lavatory Faucet
(w/ Pop-Up Waste)

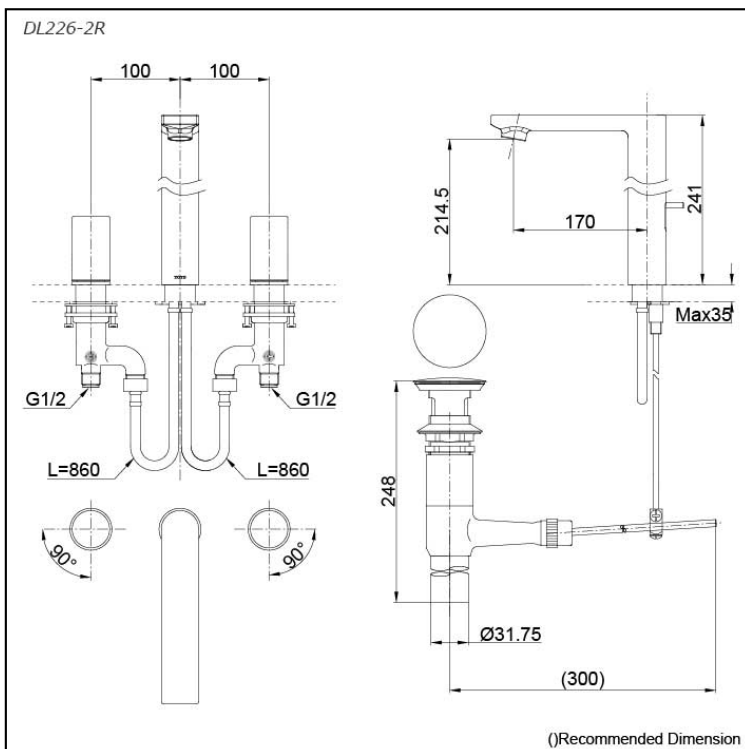

Flow Rate

DL226-2R

