

CI CONTEMPORARY  
2 Handle Lavatory Faucet (w/ Pop-Up Waste)  
(3 Holes)



### Features

- Contemporary styling
- TOTO aerated water technology, ECOCAP adds air to the water to achieve full water jet with less amount of water usage

### Specifications

Finish: Chrome  
Material: Brass  
Water Pressure: 0.05MPa~0.75MPa

### Parts description

- **DL226-1**  
2 Handle Lavatory Faucet  
(w/ Pop-Up Waste)

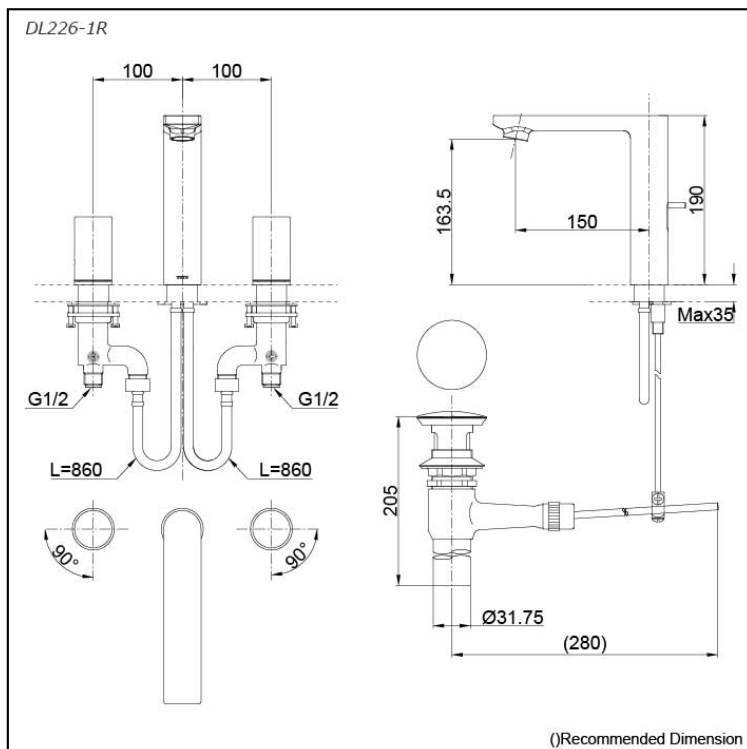

### Flow Rate

DL226-1R

